

**DH-14 and DHR-14 Series Contactors, Rated up to 25 Amps,
115/200 VAC, 400 Hz**

See Part Number Listing on Last Page

Product Facts

- 3PDT
- Hermetically sealed
- Auxiliary contacts available
- Meets many requirements of MIL-PRF-6106

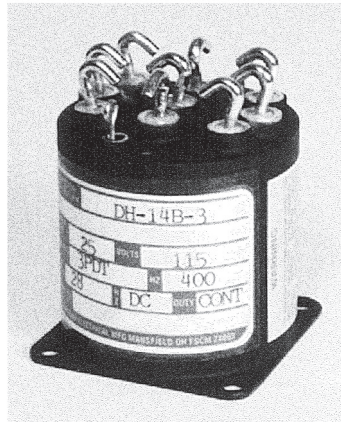

Performance Data

Electrical Characteristics

- Contact Arrangement** — 3PDT
- Rated Operating Voltage** — 115/200 VAC, 400 Hz
- Resistive Rating** — 25 Amps
- Inductive Rating** — 20 Amps
- Motor Rating** — 15 Amps

General Characteristics

- Temperature Range** — -55°C to +71°C
- Operating Cycles (Life) at Rated Resistive Load, Min.** — 50,000 cycles
- Operating Cycles (Life) Mechanical, Min.** — 100,000 cycles
- Dielectric Strength** — All Circuits to Ground — 1,500 Vrms
Circuit to Circuit — 1,500 Vrms
Coil to Ground and Aux. Contacts — 1,000 Vrms
- Insulation Resistance, Initial** — 100 megohm min.
- Altitude** — 80,000 ft.
- Weight, Max.** — .41 to .50 lbs

Duty Cycle —

- VAC 400 Hz — AC Continuous (Type A, See diagram below)
- Vdc — Continuous or continuous with suppression (See diagram B & C below)
- Operating Voltage, Nom.** — VAC 400 Hz — 115 VAC
Vdc — 28 Vdc
- Pickup Voltage @ 25°C, Max.** — VAC 400 Hz — 95 VAC
Vdc — 18 Vdc
- Dropout Voltage @ 25°C, Max.** — VAC 400 Hz — 25 VAC
Vdc — 1.5 to 7 Vdc
- Coil Resistance ±20% @ 25°C** — VAC 400 Hz — N/A
Vdc — 290 Ohms

Coil Characteristics

Coil Type

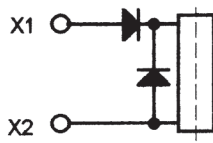

A — AC Continuous

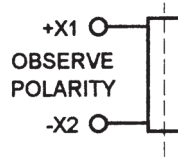

B — Continuous

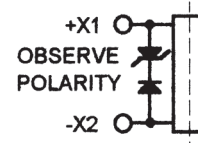

C — Continuous with Suppression

For factory-direct application assistance, phone 419-521-9500 or fax 419-526-2749.

**DH-14 and DHR-14 Series Contactors, Rated up to 25 Amps,
115/200 VAC, 400 Hz (Continued)**

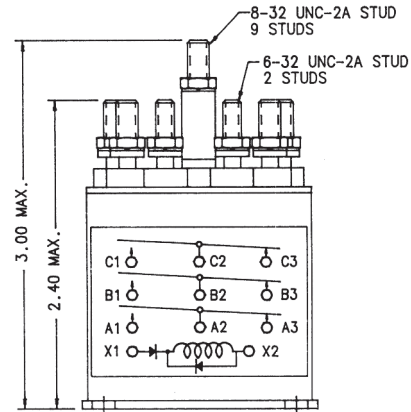
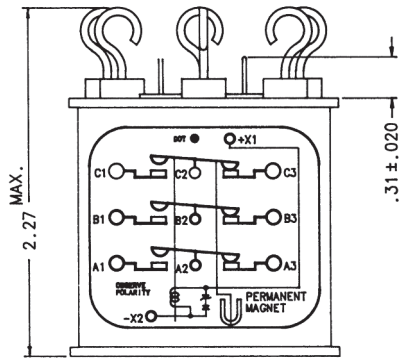
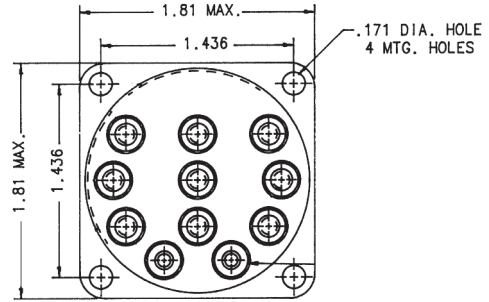
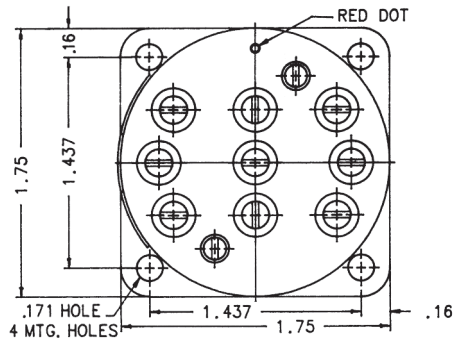

Mounting Style A

Mounting Style B

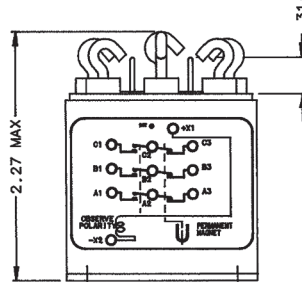
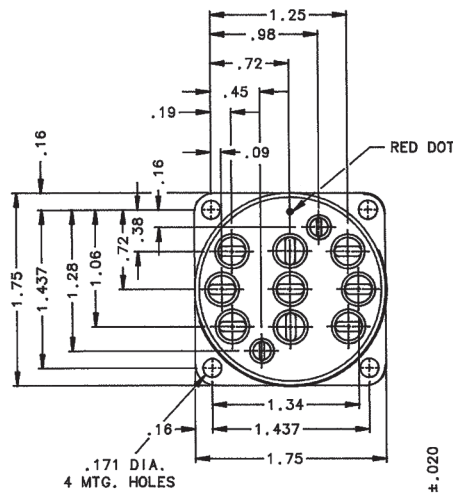

Mounting Style C

For factory-direct application assistance, phone 419-521-9500 or fax 419-526-2749.

**DH-14 and DHR-14 Series Contactors, Rated up to 25 Amps,
115/200 VAC, 400 Hz (Continued)**

Circuit Configurations (Consult factory for other available circuit configurations)

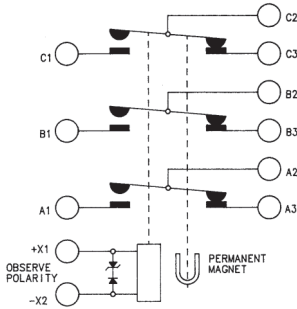

Circuit Configuration 1

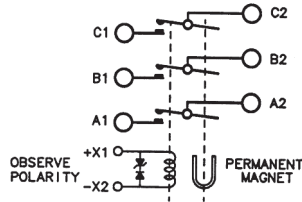

Circuit Configuration 2

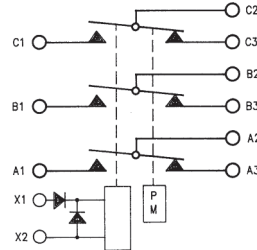

Circuit Configuration 3

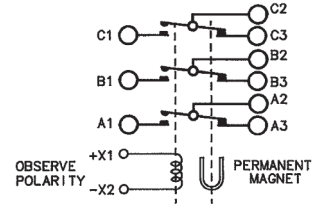

Circuit Configuration 4

HARTMAN Part Number	Construction Type	Mounting Style	Coil Type	Circuit Config.	TE Connectivity Part Number
DH-14B	Hermetically Sealed	C	B	4	1-1616522-4
DH-14B-3	Hermetically Sealed	A	C	1	1616037-1
DH-14CE	Hermetically Sealed	A	C	2	1616017-1
DHR-14B	Hermetically Sealed	A	A	3	1-1616037-2
DHR-14BA	Hermetically Sealed	B	A	3	1-1616037-3

For factory-direct application assistance, phone 419-521-9500 or fax 419-526-2749.